



Our Mission

Supplying the right solutions at the right time with our expert customer care throughout Western Canada.

Our Vision

Be the preferred wholesaler by providing superior customer experiences.

Our Values

DEPENDABLE

Even in the most pressing moments, we are aiming to be there with timely service and in-stock product.

PROACTIVE

Pursuing the latest industry products, trends, and technologies to optimize our service offerings.

KNOWLEDGEABLE

Our employees possess the knowledge to ensure our customers are receiving the right information to make the right decisions.

PROUDLY CANADIAN

We pride ourselves on being 100% independently Canadian owned and operated, to better serve our local communities.

COLLABORATIVE

Working together with our employees, suppliers, and customers, to ensure the best service is being provided.

CARING

Looking after our employees and customers the way we would want to be looked after.

Our Valued Suppliers

HEATING

A.O. Smith	6
Amtrol	8
Armstrong Fluid Technology	9
Axiom Industries	10
Bradford White	11
Chemfax	12
Continental	13
Flexcon Industries	14
Grundfos	15, 16
Hi-Velocity	17
Kane	18
Noritz	19
Modine	20
NTI Boilers	21
Resideo	22
Stelpro	23
Stiebel Eltron	24
Sunstar Heating Products	25
Watts Water Technologies	26
Weil-McLain	28

PLUMBING

American Standard (Lixil)	30
Access Flow Products (NCI Canada)	32
Apollo Valves (Aalberts IPS)	34
Bemis	33
BMI Canada	36
Canplas	37
Canature Watergroup	38
CB Supplies	40
Cello Products	42
Delta Faucet (MASCO)	43, 44
Elkay (Zurn Elkay)	45
Franke Kindred Canada	46
Gastite	53
Gerber	48
Great Lakes Copper	35
Grohe (Lixil)	54
Heatlink Group	55
Hytec (Kohler)	56
InSinkErator	57
IPEX	58

Liberty Pumps	59
LynCar Waterline	60
Milwaukee	61
MAAX	62, 64
M.A. Stewart & Sons	65
Master Plumber/BrassCraft (MASCO)	66
Moen	67
Murdock (Dobbin Sales)	68
Oatey	69
OS&B	72
Ridgid	73
Saniflo SFA	70
SharkBite (RWC)	74
Sioux Chief	75
Sluyter	76
Taylor Walraven	77
Tenzo	78

ELECTRICAL

Ace Manufacturing Metals	82
Broan NuTone	83
East Electrical Supply	84
Genlyte Solutions (Signify)	85
Honeywell (Generac)	86
Ideal Industries	87
Intermatic	88
Kidde Canada	89
Leviton	90
Liteline	91
Lithonia Lighting (Acuity Brands)	92
Mersen Canada	93
National Cable Specialists	94
Nexans	96
Stanpro (Standard Products)	95
Techspan	97
Westlake Pipe & Fittings	98

DISCLAIMER: Bartle & Gibson strives for excellence in advertising & promotion; however, not all products are as illustrated. Product selection may vary by branch location. Efforts will be made to supply similar products at similar prices or "Special Order" product for prompt delivery. All products are offered subject to availability and prior sales. B&G is not responsible for human or mechanical error. Any discrepancies will be posted at Branch Sales Counter. Contract & Marketing area prices may vary.

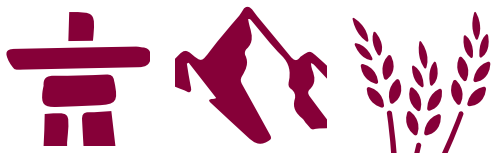

Our Services

At Bartle & Gibson, we offer an array of services to serve you better.



HYDRONIC HEATING DESIGN

Also referred to as radiant heating, this energy efficient heating runs hot fluid tubing beneath the flooring to effectively warm your space.



COMMERCIAL LIGHTING DESIGN

Lighting plays a crucial role in cultivating the mood and atmosphere of spaces, which can affect individuals' behaviours.



WATER PUMPS AND SOFTENERS

Water softening is the removal of calcium, magnesium, and other metal cations in hard water to enhance water quality.

HEATING

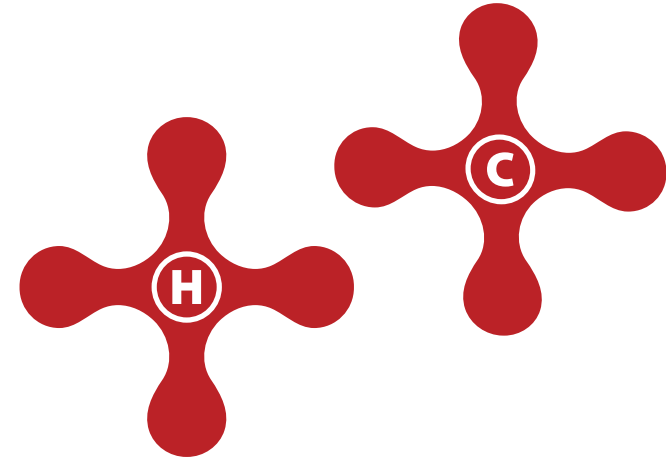

HISTORICAL FACT

In 1944, Charlie Bartle of Victoria, BC, and Cecil Gibson of Vancouver, BC, each started a store in their respective city, and Bartle & Gibson opened its doors for the first time.

NEW!

Adapt™ Premium Condensing Gas Tankless Water Heater

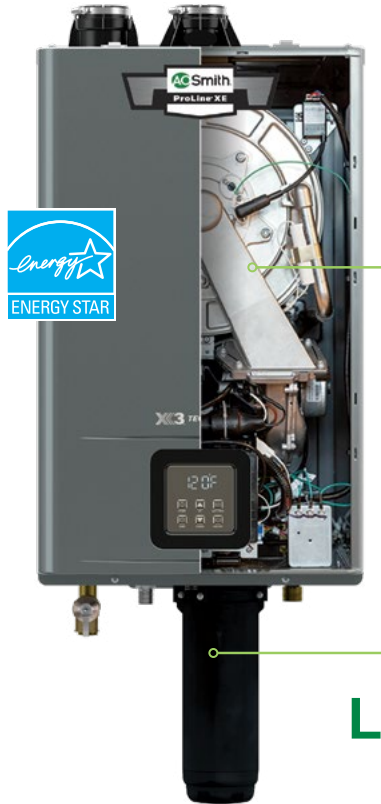

Conquers hard water.

Technology designed for tough Canadian water.

SINGLE STAINLESS STEEL HEAT EXCHANGER designed with **minimal welds** to prevent scale build-up.

X3™ SCALE PREVENTION technology **eliminates regular descaling service** and hard water problems.

Lasts 3x longer!*

Unprotected
Failed at 5.8 simulated years and 136,000 gallons.



X3™ protected
Still running after 19.7 simulated years and 460,000 gallons.

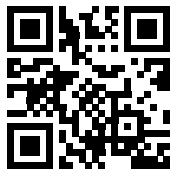

hotwatercanada.ca

Cyclone™ Series

The best keeps getting better.



PERFORMANCE. EFFICIENCY. DURABILITY.

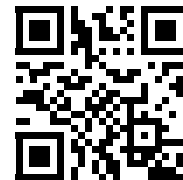

hotwatercanada.ca



THE ONE THAT DOES IT ALL.

Nearly seven decades after inventing the first diaphragm expansion tank, Amtrol's Extrol lineup now includes the Extrol Pro. This next generation expansion tank is engineered for modern, high-efficiency applications including hydronic, solar and radiant systems. The Extrol Pro features a corrosion proof polypropylene liner, high grade stainless steel connector and an industry leading 15 psi pre-charge. The Extrol was The One That Started It All™ and now the Extrol Pro is The One That Does It All™.



7
Years



AMTROL

www.amtrol.com

**WORTHINGTON
ENTERPRISES**

ARMSTRONG 

The next generation of hydronic pumping is here

INTRODUCING THE NEW DESIGN ENVELOPE PERMANENT MAGNET MOTOR PUMPS

Available in select sizes
up to 50HP (1" to 5" port sizes)

50% lower operating costs
over conventional pumps,
integrated pumps

Smaller motor and
controls size on
40% of hydraulic
selections

30% lower
installation costs

Meets the Ultra
Premium Efficiency
(IE5) standard
for motors



Try
the
App! >>



P
PUMP MANAGER™

A cloud-based Active Performance Management service for Design Envelope pumps.

WWW.ARMSTRONGFLUIDTECHNOLOGY.COM





System Feeders



DMF150



- **Simple User Friendly Control**
 - 0-45psi adjustable pressure set point
 - LED Alert indicator with dry-contact output
- **Front Fill location**
- **4.5 USG translucent reservoir tank**
- **Integrated easy connect wall bracket**

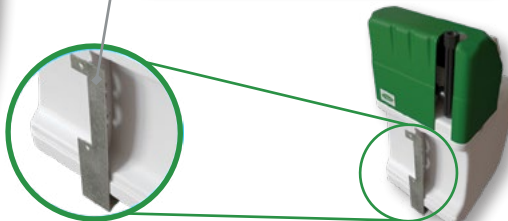

Chemical Solutions



CLEAN F-STEEL

Combustion cleaner for STAINLESS STEEL heat exchanger



Condensate Neutralizers



NC-1W



Twist off capsule allows for quick media replacement

A PERFECT COMBINATION.

THE BRUTE® FT BOILER AND POWERSTOR SERIES® INDIRECT WATER HEATER.

Together, they're an ideal hydronic solution for your customers!

Brute® FT Boiler

- High condensing boiler, fully modulating for max efficiency 95% AFUE. ENERGY STAR® certified.
- Compact design and flexible venting for easier installation.
- Available in wall-hung.



PowerStor Series® Indirect Water Heater

- Fast first-hour delivery, fast recovery.
- Available in single wall, double wall and stainless steel tank and heat exchanger models.

Learn more at forthe.pro.bradfordwhite.com





Manufacturer of Specialty Chemicals



Chem-Frost 100%



A high quality non-toxic heavy duty heat transfer fluid specifically blended for our harsh northern climates. A 100% virgin Propylene Glycol with PDT premier inhibitors to help prevent corrosion. Safe for all metals including aluminum.

We manufacture a large selection of products including:



White Magic

Caustic Drain Opener



Blast

Toilet Bowl Cleaner



Strike

Acidic Drain Opener



Kling On

Urinal Descaler



GLD -30°C

Gas Leak Detector



chemfax.com

The most EFFICIENT solution to heat and cool your home

Build **Quality**, Build **Confidence**.
continentalcomfort.com

CONTINENTAL





Flexcon Argosy Composite Buffer Tanks

Argosy is the only pressurized composite buffer tank on the market!



R-VALUE: 43% higher than the next leading buffer tank of comparable volume*

HEAT LOSS: 41% less per hour than the next leading buffer tank of comparable volume*



Flexcon HTX and SXHT Hydronic Expansion Tanks

HTX and SXHT, the ultimate hydronic expansion tanks, to help expand your business.



Announcing the Flexcon Industries Tank Sizing Mobile App

TANK SIZING MADE SIMPLE
THE LATEST INNOVATION BY FLEXCON INDUSTRIES

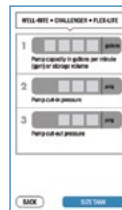

www.flexconind.com

The next step in hydronic circulator pumps

Introducing the fully digital ALPHA

Connected and fully digital, you now get a pump that automatically adapts. Experience a new level of intelligence and performance that guarantees you're ready for whatever comes next – so you can do more with confidence.

Deliver the most efficient solutions to homeowners with the digital ALPHA.



Discover more:
grundfos.to/BG-HEATING



Possibility in every drop





The next step in hot water recirculation

Introducing the all-digital ALPHA COMFORT SYSTEM and ALPHA HWR

Experience the most energy-efficient pumps on the market today, featuring new smart features like the built-in Bluetooth timer, temperature sensor, and intelligent flow control. Enjoy a much easier installation by giving your customers the comfort of instant hot water, saving up to 12,000 gallons of water per household annually.

**ALPHA
COMFORT SYSTEM**
For homes
without a dedicated
return line

ALPHA HWR
For homes
with a dedicated
return line



Discover more:
grundfos.to/BG-HWR

GRUNDFOS 
Possibility in every drop

Hi-Velocity Systems™

Small Duct High Velocity Heating and Cooling Systems



Multi-Outlet (2, 3 or 4)
HE-Z Series Air Handler
w/ Zoning Package



Space Saving Flexible Duct

- Clean Comfortable Air
- Energy Smart HVAC
- Efficient Installation
- Quiet Operation

**From Cost Saving Multifamily Builders Series
to Custom Luxury Home Applications**



Also Available!
1 & 2 Ton
Cube Air Handler
10 Ton
HE-P Air Handler



Proudly Manufactured in Alberta since 1983
See all products at www.hi-velocity.com





**IF YOU'RE NOT TESTING...
YOU'RE GUESSING**

KANE258KIT
Combustible gas analyzer



KANE3300
Differential Manometer

KANE579
600A True RMS HVAC/R
Clamp meter



HUB4
Wireless
Smart refrigeration
Charging Kit



Test & Measurement tools for Professionals Since 1954

www.kanetest.ca

NORITZ®
**UNMATCHED
PERFORMANCE
MEETS THE INDUSTRY'S
BEST WARRANTIES**



EZ SERIES

Model# EZ98DV / EZ111DV



**HYBRID HOT
SERIES**
BY NORITZ

Model# NHH199100-1



NRCCR

Model# NRCCR92DV / NRCCR111DV



**SCAN TO WATCH
OUR HYBRID HOT
EXPLAINER VIDEO**

NORITZ®
TANKLESS WATER HEATERS

Whether you're looking into faster hot water for your home or meeting the demands of a growing business, Noritz has you covered with the latest and greatest in tankless technology. Designed with both residential and commercial customers in mind, our line of tankless water heaters offers peace of mind with our proven reliability and industry-leading warranties.

NORITZ AMERICA | WWW.NORITZ.COM





ENJOY YEAR-ROUND COMFORT TO WORK, PLAY AND RELAX



Hot Dawg® Gas-Fired Unit Heaters (HD/HDS)

Hot Dawg™ H2O Low-Profile Hot Water Unit Heater (HHD)

Amp Dawg™ Electric Unit Heater (AMP)



NEW



Products you need from people who care



NTI COMPASS

CHOOSE YOUR OWN DIRECTION!

The latest addition to our product lineup is the NTI Compass, designed with a keen focus on flexibility, easy accessibility, and top-notch efficiency. Featuring independently reversible plumbing connections, this boiler empowers you to choose your own direction.

REVERSIBLE CONNECTION

NEWEST FLOOR MOUNT MODEL

FROM 85 – 199MBH

95 – 96% AFUE

ADVANCED HMI WITH INTUITIVE DISPLAY!

Includes: Primary/Secondary Piping | ECM Pump | Wi-Fi

www.ntiboilers.com

Scan for more info:





Seamless Integration



Resideo Hydronic Solutions

► Stock Up Today!

From hydronic heating controls to mixing valves, Resideo Water Solutions are designed to work together to make your job easier. And now with our newly expanded hydronic portfolio you can get all your hydronic parts in one place – saving you time, labor, parts and money.



Sign up for Pro PERKS and earn up to 3% cash back on water purchases.

To Learn more visit, resideo.com/pro/water

© 2023 Resideo Technologies, Inc.

°STELPRO

PRIMA™ HIGH-END COMPACT BASEBOARD

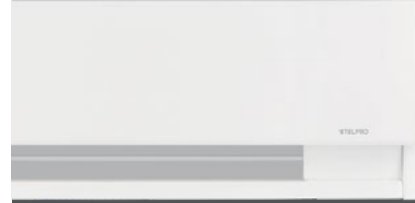

Compact and efficient
Safer construction
Impact resistant
Quick and easy installation

SPIDER™ CEILING FAN HEATER



Unique design
Specially designed for residential garages
Energy saving, compatible with 4000 W electronic thermostats
Ceiling installation frees up walls and storage space

MIRAGE™ CONVECTOR



Blends discreetly with any decor
Sturdy monocoque front panel
Available in 120 V, 208 V, 240 V, 347 V and 600 V

[WWW.STELPRO.COM](https://www.stelpro.com)





Quality is key.

- › You buy the best tools because you learn broken tools cost time and money. *Then you learn bad products do the same.*
- › Customer call backs cost more than time and money. *They hurt your reputation with your customers and your ability to grow new business.*
- › We invented electric tankless water heaters and are the largest manufacturer in the World. *These are the ones that work.*



Electric tankless single-phase point-of-use from 1.8 kW for hand washing, to whole house up to 36 kW; plus three-phase up to 144 kW.



Engineering & manufacturing excellence... since 1924.

STIEBEL ELTRON

Simply the Best

www.StiebelEltron.us

Lower Your Customer's Fuel Bills

Up To 50% With SunStar Infrared Heaters

SPS & SPU SERIES TUBE HEATERS



SPS SERIES

Available in multiple configurations (straight, L, Z and expanded U-configuration) with lengths up to 70 feet. Ideal for complete building heating.

SPU SERIES

Provides more uniform radiant heat energy distribution. Ideal for high heat loss areas and spot heating.

MODELS	SINGLE STAGE BTU/HR INPUT	TWO STAGE		TOTAL EMITTER TUBE LENGTH						MIN. MOUNTING HEIGHT AT HORIZ.	
		BTU/HR HIGH INPUT	BTU/HR LOW INPUT	10'	20'	30'	40'	50'	60'		70'
SPS/U 40	40,000	40,000	25,000	●	●						10 FT
SPS/U 50	50,000	50,000	30,000		●	●					11 FT
SPS/U 75	75,000	75,000	50,000		●	●	●				13 FT
SPS/U 100	100,000	100,000	65,000			●	●				14 FT
SPS/U 125	125,000	125,000	80,000			●	●	●	●		14 FT
SPS/U 150	150,000	150,000	100,000				●	●	●	●	15 FT
SPS/U 175	175,000	175,000	110,000					●	●	●	16 FT
SPS/U 200	200,000	200,000	125,000					●	●	●	18 FT

- CSA Certified
- Heavy Duty Reliable Cast Iron Burner
- Reliable Direct Spark Ignition System
- Diagnostic Monitoring Light System
- Tough Guy Option
- Highly Efficient Aluminum Reflectors With 97% Reflectivity Rating
- 24V External Thermostat Connection
- TISS – Tube Integrity Safety System
- Sidewall Or Roof Venting

Other Infrared Heaters From SunStar

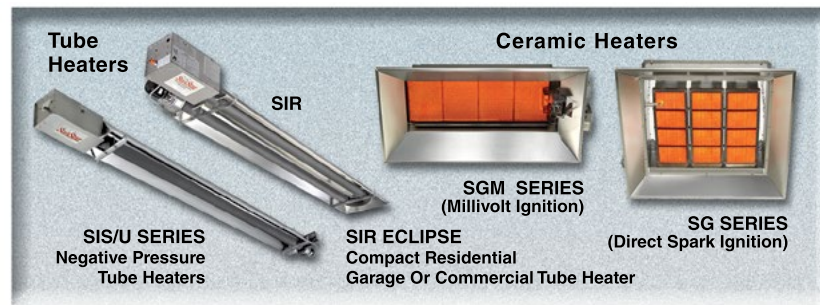

Tube Heaters

SIS/U SERIES
Negative Pressure
Tube Heaters

SIR

SIR ECLIPSE
Compact Residential
Garage Or Commercial Tube Heater

Ceramic Heaters

SGM SERIES
(Millivolt Ignition)

SG SERIES
(Direct Spark Ignition)

SunStar Heating Products, Inc.

www.sunstarheaters.com

© 2012 SunStar Heating Products, Inc.





Every Drop Counts



Celebrating a 150 Year Legacy of Water Safety Innovation

Water. It's in our name and close to our hearts. Since 1874, Watts has delivered innovative technologies that make the world's most precious resource safe and accessible. Every effort, like every drop, has a ripple effect. Together, we can create a more sustainable world today and tomorrow.



Join the Celebration



Innovative Comfort Solutions

Commercial & Residential Radiant, Snowmelt and Hydronic Packages



RadiantPERT and Radiant PEX Tubing

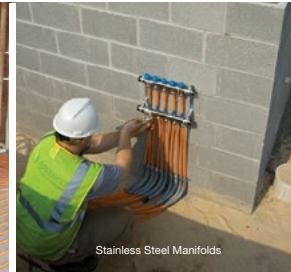

Stainless Steel Manifolds



Promett Smart Controller



W561 Wifi Thermostat



Hydronic Boiler Package



Tankless Water Heater Valves



BD911 Boiler Fill & Feed Valves



Press Enabled Valves



740 & 174A Boiler Pressure Relief Valves & Flood Sensor

Scan to Learn More:

Hydronic & Steam Heating Solutions

Radiant Heating & Snowmelt Solutions



Watts.com



Get connected with Eco[®]Tec Series 2

NOW Bluetooth-ready and accessible through our ProTools App: tech chat, warranty support, boiler operational logs, performance monitoring, fault lookups and more at your fingertips.



Also available on **Google Play**

www.weil-mclain.ca



PLUMBING

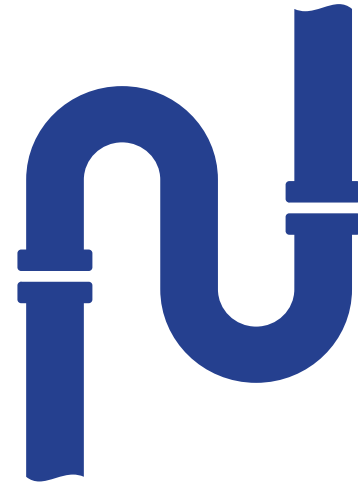

HISTORICAL FACT

In the 1960's, new branches were established in Edmonton, Calgary, Medicine Hat, New Westminster, North Vancouver, Surrey, and Yellowknife.

American Standard

LIFE.LOVE.HOME



The Studio S kitchen collection from American Standard provides an urban-inspired aesthetic with superior functionality. Upgrade your kitchen with a dual-spray pull-down kitchen faucet and wall-mount pot filler.

AFP ACCESS
FLOW PRODUCTS



Leading manufacturer and supplier of high-quality valves, fittings, strainers, and gauges.

Flow+

NCI
PIPE · VALVES · FITTINGS

SSI
STRAINERS

WGI
WESTERN
GAUGE
& INSTRUMENTS

LESSO®

NIBCO
AHEAD OF THE FLOW™

Webstone
a brand of **NIBCO**



VISIT US ONLINE TODAY AT
accessflowproducts.com

BEMIS

WATER DOES IT BETTER®

HAVEN 5000™
BIDET SEAT



- Auto Open/Close
- Warm Air Dryer
- UV Self Clean Nozzle
- Wireless Remote
- Low Profile Design
- Heated Seat
- Night Light
- Multiple Wash Functions
- Unlimited Warm Water
- Stainless Steel Nozzle
- Sittable Lid

ToiletSeats.com



valve and piping solutions

don't just buy products, buy solutions.

At Aalberts integrated piping systems, we create mission-critical products surrounding valve and connection technology.

Our group creates systems that are applicable for key verticals as residential, commercial, industrial, and utilities, and are designed and developed by our team of in-house engineers.

materials

- brass
- bronze
- carbon steel
- ductile iron
- copper / steel
- lead-free brass
- leaded brass
- stainless steel

types

- threaded
- solder
- copper press
- carbon steel press
- stainless steel press

applications

- heating
- plumbing
- HVAC
- fire protection
- sprinkler
- steam
- compressed air



Quality Inspected, Customer Trusted

Having built a reputation on delivering a quality product for decades, the Great Lakes Copper Ltd brand has been a sustainable and trust-worthy source for our customers. Our facility complements our reputation by utilizing the most current technology to ensure each length or coil that leaves our facility has been quality inspected and approved so each installation is done with confidence and with a quality product.



BMI PRESS

A WIDE RANGE OF PRESS PRODUCTS



Adjustable Waste & Overflows allow for various bathtub slopes. Models in ABS or PVC



canplas® Plumbing Fittings

Consistent Quality & Supply of plumbing fittings for over 55 years.

ABS & PVC Backwater Valves 1.5", 2", 3", 4" and 6" Models

2" Great White Tiled Shower Drains

endura® 7-150 GPM Grease Interceptor

Endura consistently offers high performance hydromechanical grease management, with some of the industry's highest fats, oil and grease separation efficiencies.



High Capacity XL 75 GPM Models

High Capacity XL 100 & 150 GPM Models

7, 10, 15, 20, 25, 35 & 50 GPM Models

Solids Interceptors

The Endura Solids interceptors offer solutions for small, medium and large output applications. Available in 2", 3" & 4" connection sizes and may accommodate flow rates up to 125 GPM.

2" Model



3" & 4" Models



4" High Capacity Models

canplas®
www.canplas.com



WaterGroup®

Make the Most Out of Your Water Conditioning Opportunity ...



Water Softeners



Problem Water Solutions



Specialty Systems

AQUA FLO®



Certified for the reduction of PFOA/PFOS and Lead

Drinking Water

AQUUV®



Ultraviolet

AQUA FLO®



POU Filtration

Online Training Opportunities

Level 1 Basic Training:

- On-demand water treatment basics in under 30 minutes.

Webinar Series:

- 10-week live, online training program led by experts. Earn a free water softener for your home.

Scan for Webinar Information:



THE COMPLETE PLUMBER

A Division of **Canature WaterGroup**

www.watergroup.com

State-of-the-Art Commercial Water Treatment



Our multi-tank systems (MTS) will take your project to a higher level of water quality and efficiency.

- ◆ Softening, filtration and RO systems for all commercial & industrial applications
- ◆ Industry-leading efficiency: 40-50% less salt and regeneration water
- ◆ Our dedicated applications team will custom select systems to suit your specific operating and water quality conditions



Canature WaterGroup
Commercial/Industrial Engineering Division

canaturewg-cied.com



CB Supplies VIPERT™ Potable & Radiant PE-RT OXY barrier tubing offers industry leading performance with improved flexibility, lowest Greenhouse Gases (GHG) emission footprint and tubing is 100% recyclable, all backed by a 25-year warranty that is not compromised by your connection choices.



INDUSTRY LEADING FLEXIBILITY FOR EASIER & FASTER INSTALLATION

With relaxed memory you'll experience less spring back than PEX for easier and faster installations



100% RECYCLABLE

VIPERT is 100% recyclable, requires less energy to produce compared to PEX tubing, contributing to lowest GHG emissions footprint



EXPAND, CRIMP OR PUSH

VIPERT Potable and Radiant is flexible for your preferred tubing methods by expanding, by crimp or with push style fittings, VIPERT does it all!

STRIKING PERFORMANCE



NO NONSENSE 25-YEAR WARRANTY

We stand behind our VIPERT with a transparent 25-year warranty regardless of fitting systems installed



STRENGTH, DURABILITY & BUILT FOR EXTREME TEMPERATURES

Exceeds all standards with exceptional hydrostatic strength at high temperatures and burst pressures, maintains excellent flexibility in both cold and hot environments



EASY LINE IDENTIFICATION BY COLOUR

White, red and blue choices for Potable and VIPERT green for Radiant, available tubing sizes: 3/8" through 2"



RADIANT



POTABLE



cbsupplies.ca



CELLO PRODUCTS

Premier copper solder fittings manufacturer in North America and one of the only cast brass fittings producers



Fittings Uses

Ranging from underground water and gas services to water distribution and air conditioning systems as well as drainage, waste and vent piping for use in residential, commercial, industrial and institutional applications.

Types of Solder Fittings

Wrought Copper Pressure, Cast Brass Pressure, Wrought Copper Drainage, and Cast Brass Flanges

Brass Fittings

Cello manufactures a portion of its cast threaded brass product line and does custom casting for special order fittings.



Also Offering a Complete Line of Press Fittings from 1/2" to 4".

celloproducts.com



COMMERCIAL



EXPERIENCE THE PERFECT STYLE WITH ADVANCED FUNCTIONALITY

Architectural™ Design Series

Cutting-edge plumbing products that do not compromise on quality or durability. Featuring hands-free technology that incorporates beautiful aesthetics for high-use areas such as hospitality, transportation hubs, retail, and offices.

Customize your space with three design options and four exquisite finishes available in the Architectural™ Design Series.



Driftex™ Collection
Electronic Faucet/Soap Combo
810DPA20-BLSD



Contrasta™ Collection
Electronic Faucet/Soap Combo
820DPA20-SSSD



Rustica™ Collection
Electronic Faucet/Soap Combo
830DPA20-CZSD



SCAN FOR MORE

deltafaucet.ca/commercial
COMMERCIAL PLUMBING SOLUTIONS



MULTICHOICE[®] UNIVERSAL VALVE

One Rough. Three Function Options.
Extensive Style and Finish Choices.



**MONITOR[®]
13 & 14 SERIES**
Temperature
Control



**MONITOR[®]
17 SERIES**
Temperature &
Volume Control



**TEMPASSURE[®]
17T SERIES**
Thermostatic
Temperature &
Volume Control

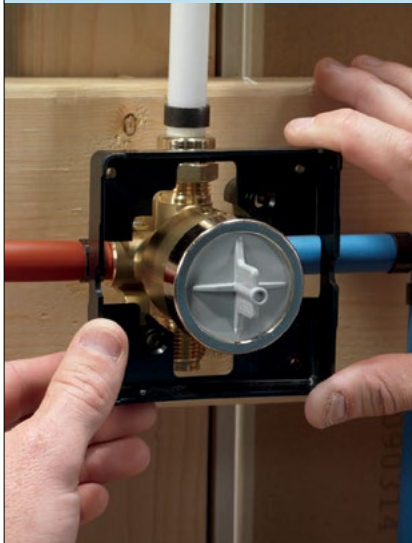

FLEXIBILITY

Upgrade shower style and functionality without altering the plumbing behind the wall.

SAVES TIME AND HASSLE

Only one rough to install, saves time and money on mid-construction changes and renovations.

OPTIONS AVAILABLE

Can be purchased with or without stops. Pre-fabricated options available with tub drop or shower only. Three connection type options: IPS, PEX and Universal.

ALSO COMPATIBLE WITH BRIZO  WALTEC  PEERLESS



Custom Stainless Solutions

Bring your vision to life with our custom and modified stainless steel sinks and sink tops. It's where form meets function to create a space worth celebrating.

©2022 Elkay Manufacturing Company

elkay.com/custom

NIGHTINGALE HAND WASH BASINS



Elegant & accessible

The Nightingale family of patient room hand wash basins are wheelchair accessible and available in 4 models. Our latest version features an anti-ligature shroud. Find out more: franke.com



Residential



The recipe for

Change

Complete solutions for residential, and multi-family.

Our extensive range includes customer-favorite products and options to meet any requirement.

Stainless Steel Residential & Multi-Family Sinks
Granite Sinks
Faucets
Filtration Systems
And More...
www.franke.com

KINDRED A Franke Brand

EZ-TORQUE™ Hassle Free Installation



Place sink into the countertop.



Tighten fasteners to secure in place.



Multi-Family



“Hello gorgeous.”



D225079BN

Say ‘hey’ to the new Northerly™ collection.

Classic details. Modern lines. Breathtaking, quality faucets at a price point so reasonable that it may leave everyone speechless.



GERBER

**Same great service,
available online soon.**

 **FIND**
Find products and inventory by location

 **ORDER**
Easily place orders and reorder products

 **ACCESS**
Access live pricing and purchase history

 **MANAGE**
Manage quotes and product lists

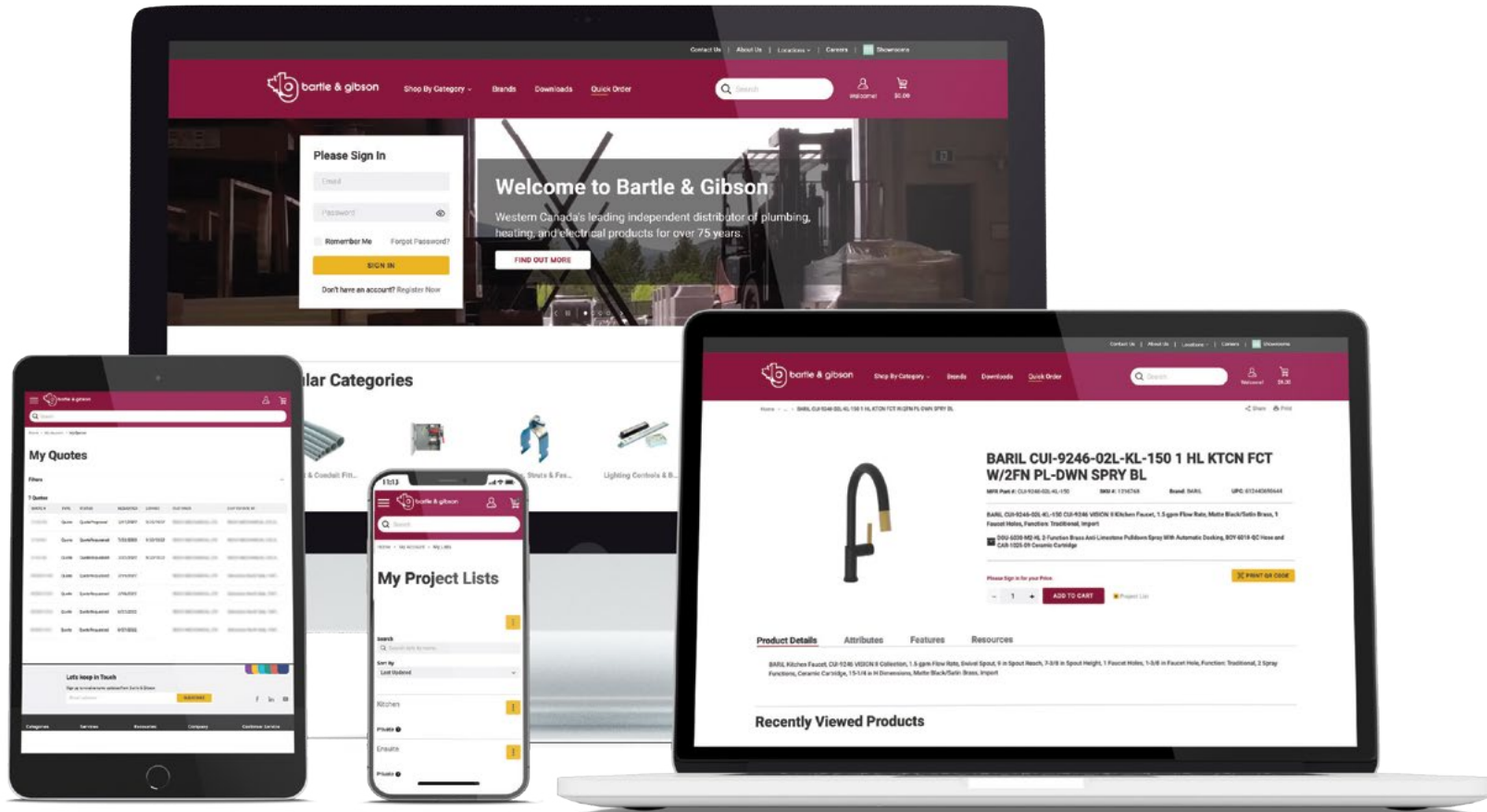



80 YEARS OF BUILDING CAREERS

- COMPANY-PAID BENEFITS
- PROFIT-SHARING
- CAREER GROWTH
- ON-THE-JOB-TRAINING
- RECOGNITION PROGRAM
- GIVEBACK PROGRAM

Scan QR Code to
Access our Careers Page



Build yours today at bgcareers.ca



FlashShield⁺
ENHANCED PROTECTION

You're not just installing safer,
you're installing **better.**

FOUR LAYERS OF SAFETY. JUST ONE CUT.

THE NEXT EVOLUTION IN CSST.

INSULATIVE POLYMER LAYER
protects against arcing damage
associated with electrical system
failure and malfunctions.

POLYESTER LAYER
adds strength to jacket to
prevent tearing and ripping.

**ALUMINUM SHIELD AND
INNER POLYMER LAYER**
protect against greater
voltage and current levels
associated with direct and
indirect lightning strikes.

To learn more about FlashShield⁺, visit gastite.com/plus

GROHSAFE 3.0 PRESSURE BALANCE VALVE WITH INTEGRATED DIVERTER

Pure Freude
an Wasser



FLAT BACK

Easy & solid installation allows the valve to be mounted flush with the cross brace

ALIGNED INLETS & OUTLETS

Eliminates potential for misaligned piping & rough-in mistakes from different cross brace depths

2-WAY & 3-WAY CONVERTIBLE

Use same valve body for both 2-way & 3-way applications

DIVERTER TEST CAP

Eliminates need to remove cartridge during installation for testing & flushing lines

CONNECTION OPTION:



1/2" Universal inlet/outlet for PBV & integrated diverter

GROHSAFE 3.0 PRESSURE BALANCE VALVE

DZR BRASS

Durable, corrosion-resistant construction for dependable performance

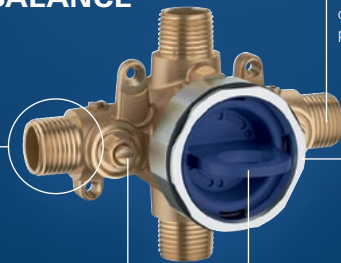

MULTIPLE CONNECTIONS

Choose from various piping connections for faster installation

SERVICE STOPS

Allows for easy servicing at the valve

RETAINING RING

Quick & easy to remove for access to the cartridge

FLUSH PLUG

Makes flushing & testing of valve quick and easy

CONNECTION OPTIONS:



1/2" Universal inlets/outlets



1/2" PEX cold expansion (ASTM F1960) inlets



1/2" PEX crimp (ASTM F1807) elbow inlets



1/2" PEX crimp (ASTM F1807) inlets



1/2" Stub-out inlets/outlets



1/2" PEX cold expansion (ASTM F1960) elbow inlets

New!

1-1/4" Stainless Steel Manifolds

- Preassembled configurations from 2 to 12 loops.
- 0-2 US gpm (0-7.5 L/min) flow meters.
- 18 US gpm (4.1 m³/h) max. trunk flow rate.
- Integrated 1" FNPT isolation valves and hosebibs.
- Zone valve return with manual shut-off; accepts optional actuators.
- 1/2", 5/8", and 3/4" PEX connectors available in compression and F1960 expansion.

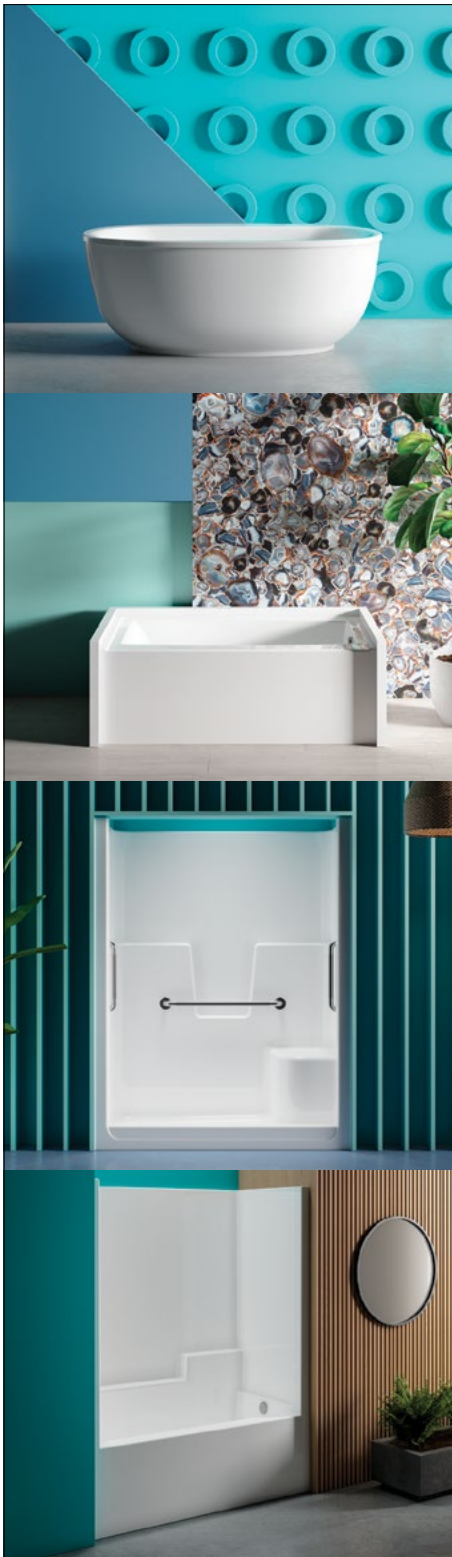

With over 45 years in business, Hytec is a leading manufacturer of quality bath products. With an extensive range of attractive functional designs and a wide variety of enhanced bathing options, HYTEC® fixtures are favoured by plumbers and building professionals.

- Freestanding Baths
- Drop-In Baths
- Alcove Baths
- Showers & Bath/Showers
- Shower Bases

hytec.ca

in sink erator®

GRIND FEARLESS.

NEXT GENERATION FOOD WASTE DISPOSERS FOR THE PRO



EZ Connect Disposer
Simplified Hardwire and Outlet Connections



Featuring 2 levels of **SoundSeal® Technology**



Up to 4 stages of **MultiGrind® Technology**



Dura-Drive® Induction Motor



New EZ install features



®/TM © 2024 InSinkErator. All rights reserved.



**INTEGRATED
TOTAL SOLUTIONS**



System XFR® PVC DWV
System 15® PVC DWV
Drainage Systems for Noncombustible Buildings



AquaRise®
Hot & Cold Potable Water Systems



RadonX™
Soil Gas Venting System



System 636®
Flue Gas Venting Systems

Providing state-of-the-art pipe, valves, and fittings systems to meet all your project needs. Learn more at ipexna.com.

ask an expert



Liberty Pumps®

commercialseries

Innovative Wastewater Pumps that Deliver Unmatched **POWER** and **RELIABILITY**

LSS/LSV Series

- Available in 1.5, 2, 3 or 5 HP
- Single mechanical silicon carbide shaft seal
- Cast iron construction with epoxy powder coating
- Quick-connect power cords in 35', 50' or 100' lengths
- Available in 208/230V single phase or 208-575V three phase



Proudly made in the USA
with US & global components

Copyright © Liberty Pumps, Inc. 2024 All rights reserved.

One Million Items ... One Source



braided supplies



tubular brass



pex tools



rubber couplings



copper manifolds



pex valves











100 Westcreek Blvd.,
Brampton, Ontario
www.lyncar.com
www.waterlineproducts.com

M18 REDLITHIUM FORGE™

MOST POWER FASTEST CHARGING LONGEST LIFE



CHARGE TIME COMPARISON

	 FORGE™ HD12.0	 FORGE™ XC8.0	 FORGE™ XC6.0	 HIGH OUTPUT™ XC6.0	 XC5.0	
SUPERCHARGER  48-59-1815	35 MIN	35 MIN	15 MIN	25 MIN	42 MIN	TO 80% TO 100%
	45 MIN	45 MIN	25 MIN	35 MIN	60 MIN	
RAPIDCHARGER  48-59-1802	130 MIN	83 MIN	62 MIN	65 MIN	60 MIN	TO 100%
STANDARD CHARGER  48-59-1812	231 MIN	162 MIN	115 MIN	123 MIN	105 MIN	TO 100%

CHARGES ALL M18™ BATTERIES

*Estimated charge durations measured up to 80% are based on testing conducted by Milwaukee Tool® at room temperature. Up to 6X faster charging is dependent on battery model, charger model and battery state of charge. Actual results may vary. Visit milwaukeeetool.com/charge for a comprehensive list of charge durations.



NITRUS CARBIDE™

FASTEST CUTTING. LONGEST LIFE.

WATCH VIDEO



or visit <https://qr.mke.lt/28hr>

Renata

Freestanding Bathtub

Discover our matte acrylic, the **perfect solution** for affordable luxury.



Icon SERIES

The seamless one-piece design features AcrylX™ applied acrylic surface for a lustrous, easy-to-maintain finish. It offers ample wall-to-wall shelf capacity, a large deck space for bath essentials, and flat walls to accommodate optional grab bars. Plus, its minimalist design with a lower deck height makes access easier, and it's compatible with various shower doors.

AcrylX

MADE IN CANADA
WITH GLOBAL MATERIALS

MAAX
www.maax.ca



M. A. Stewart & Sons Ltd.
VALVES AND FITTINGS

M.A. STEWART & SONS LTD.

COMMERCIAL VALVE PRODUCTS

MAS ML-SERIES CHROME SUPPLY STOPS
TERMINAL SUPPLY SHUT OFF VALVES

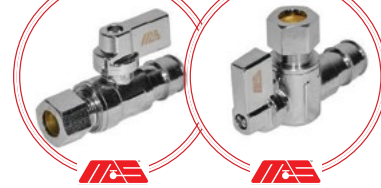

MAS A-SERIES APPLIANCE GAS BALL VALVES
CSA FOR HOT WATER TANKS & FIRE PLACES

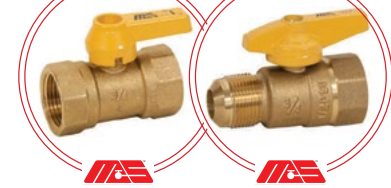

MAS B-SERIES BRASS BALL VALVES
SOLDER, NPT, LEAD FREE, SS BALL/STEM, CSA GAS FOR ROOF TOPS,
cUL for FIRE PROTECTION

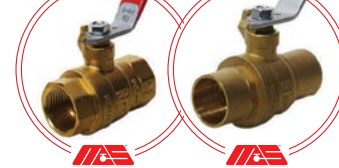

RWV HYDRONIC INSTALLATION VALVES



RWV BRASS BALL VALVES
F1807/F1960 PEX, PRESS, TRANSITION VALVES

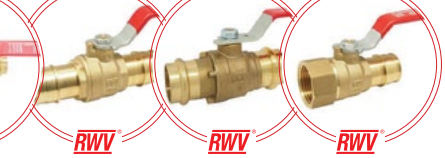

RWV BALANCING, HYDRONICS & COIL KITS

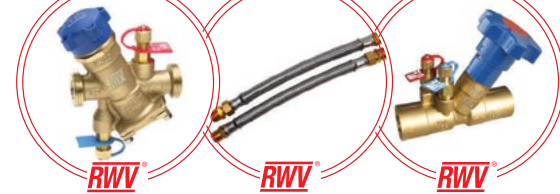

MAS D/W-SERIES BUTTERFLY VALVES
WAFFER, LUG, GROOVED, LEAD FREE, HEATING & FIRE PROTECTION



KITZ BRASS, BRONZE & IRON VALVES
GATE, GLOBE, CHECK, BALL & STRAINERS



CRN, CSA B125.14, NSF61/372, CSA GAS CERTIFICATION, cUL, DZR BRASS
For More Product Information Please Visit
www.mastewart.com

Master Plumber.

© 2023 Moen Canada Limited

The comprehensive, quality backed, parts and accessories program customized for Canadian plumbing needs. Offering a wide range of universal fit and select OEM plumbing parts for both plumbing repair and installation.



THE RIGHT PARTS.

masterplumber.ca

RIGHT HERE.



BrassCraft®

THIS IS OUR CRAFT®

PROS WHO KNOW CHOOSE BRASSCRAFT®

INTRODUCING BRASSCRAFT PRESS CONNECT WATER STOPS

STRAIGHT - 1/4 TURN PRESS CONNECT STOPS

ANGLE - 1/4 TURN PRESS CONNECT STOPS

G2CP14X CPEF

G2CP09X CPEF

G2CP19X CPEF



1/2" PRESS CONNECT x 3/8" OD COMP

1/2" PRESS CONNECT x 1/4" OD COMP

1/2" PRESS CONNECT x 3/8" OD COMP

BrassCraft.com



MOEN

SMART WATER NETWORK

MONITORING AND PROTECTING YOUR HOME FROM WATER DAMAGE

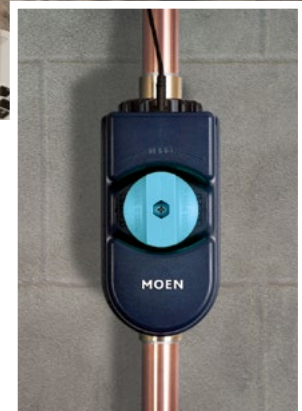

Flo® Smart Water Monitor and Shutoff

The Flo® Smart Water Monitor and Shutoff is a game-changing leak detection and water monitoring device that detects leaks anywhere in the home. This device can automatically turn off the water to the home if a leak or risk is detected, with the ability to start and stop water flow from your smartphone. It also provides real-time information on water usage in your home.



For more information on Smart Water Network products, visit moen.ca/smart-home.

H₂O-To-Go!®

Touchless Drinking Fountains & Bottle Fillers Designed with you in mind!

Fill Up. Cool Down. Get Going.
Our indoor sensor-operated filling stations provide unlimited fresh water for any application.



NEW

Ask about our custom colors, logos, and designs!

EZREACH™ COMPACT SURFACE MOUNTED CHILLED BOTTLE FILLER
MODEL NO. BFEZ168-BCD

170 years
Murdock
—EST. 1853—

www.murdockmfg.com



**INTERESTED?
LET'S TALK.**

DOBBIN SALES
LIMITED

Distributed in Canada by Dobbin Sales
dobbinsales.com



SUPPLY BOXES

Premium QUADTRO

SNAP-ON
FACEPLATE

1/4-TURN
VALVES

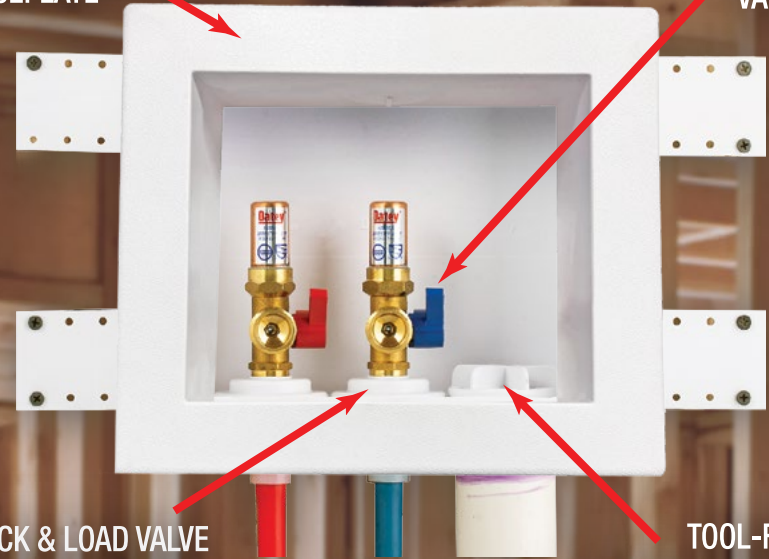

LOCK & LOAD VALVE
MOUNTING SYSTEM

TOOL-FREE
1/4-TURN TEST PLUG

Versatile MODA

Economical CENTRO II

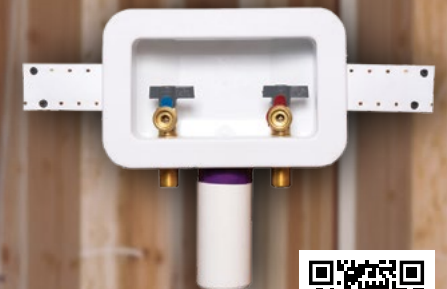
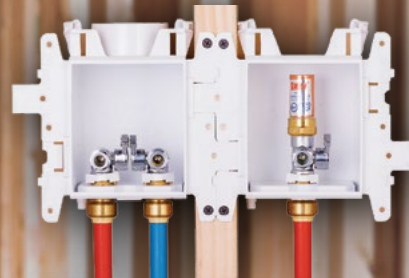

kitchen supply box shown

oatey.ca



Sanipit® 24 GRCB

RESIDENTIAL/COMMERCIAL SIMPLEX GRINDER SYSTEM



BEN APPROVED



Sanipit® 24 GR

RETROFIT 1 HP GRINDER PUMP



View Full Specs

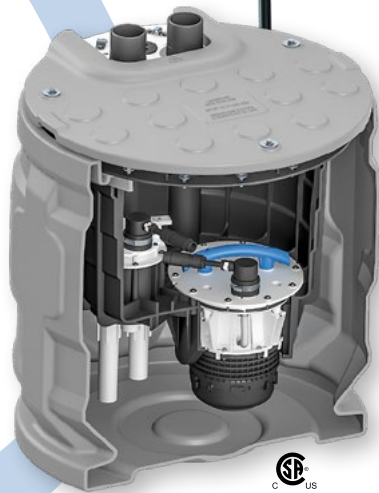

- 💧 **DRY CAVITY PIT DESIGN** for a complete white glove service. Tight seal odour eliminating lid attaches with bolts into an interlocking channel.
- 💧 Capable of **PUMPING UP TO 25 FT (SHUT-OFF HEAD: 33 FT)**. Maximum discharge flow rate: **66 GPM**.
- 💧 Equipped with **FAIL-PROOF AIR PRESSURE SWITCH** system with **triple redundancy**.
- 💧 **SUPERIOR WASTEWATER DETECTION SYSTEM** giving a longer life expectancy without any maintenance.
- 💧 **EASY ACCESS TO ALL MAJOR INTERNAL COMPONENTS** including motor, grinder blade and pressure switches for a **quick, easy and effortless maintenance**.



Scan to View Video

- 💧 FITS MOST **24 INCH** BASINS
- 💧 **ODOURLESS** DRY PIT
- 💧 **EASY ACCESS TO MAJOR COMPONENTS**
- 💧 **EXTERNAL CONTROL PANEL AND ALARM**
- 💧 **FAIL-PROOF TRIPLE AIR PRESSURE SWITCHES**

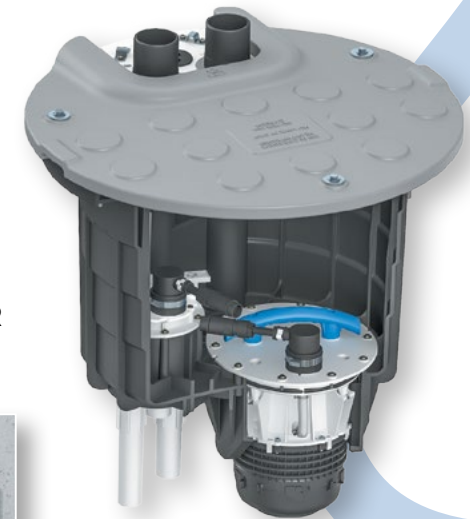

Pre-assembled packaged 24" x 24" grinding 1 HP pump system w/basin and control panel/alarm system.

Upgrade your sewage ejector pump!



saniflo.ca



saniflo.ca

Redesigned.

Our original Island Tub Drain® was groundbreaking, creating a new category and setting the industry benchmark for freestanding tub drains.

Still 100% engineered and manufactured in Canada, the newest addition to our ITD® range of products resets the benchmark with it's innovative new design and features.

Available at your favourite Bartle & Gibson branch.



Easy grip removable Debris Cover included
Sits above floor and is easy to grip and remove (actual Cover is larger than shown)

ITD® and Island Tub Drain® are Registered Trademarks of Oakville Stamping and Bending Limited.
The Red Drain® is a Registered Trademark of Oakville Stamping and Bending Limited.
OS&B® is a Registered Trademark of Oakville Stamping and Bending Limited (OS&B®).
Total1™ is a Trademark of Oakville Stamping and Bending Limited

osb.ca

OS&B
The Red Drain Company®

RIDGID



SeeSnake® microReel APX™ and CSx Via™ Bluetooth Monitor

Cat. No. 78728
Bluetooth and Wi-Fi connectivity with TruSense technology and auto-image rotation.



K9-12 FlexShaft® Machine

Cat. No. 74978
Lightweight, portable design is perfect for 1 1/4" - 2" wall to wall cleaning.



RP 115 Press Tool

Cat. No. 72553
Smallest and lightest press tool on the market.



K-4310 FXP™ Drum Machine

Cat. No. 73073
RIDGID's most powerful drum machine. Battery-powered with a Cable Counter that gives real-time feedback measuring cable distance.

Learn more at RIDGID.COM



EVEN BETTER UNDER PRESURE

Need a fitting you can trust?
Reach for SharkBite Max.



Scan to Learn More



You could Build Water Heater Loops On-Site ...

Multiple parts/pieces (numerous even)

INConsistent Results

So much time
So many parts
So much work
So many touches

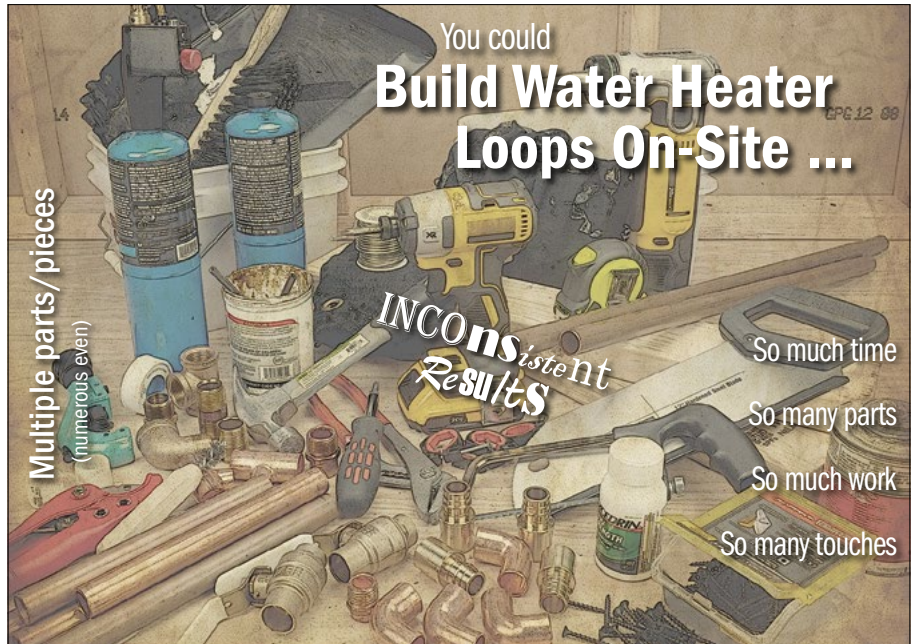

... or ServiceBox™ Water Heater Access Box

Think [inside the box]

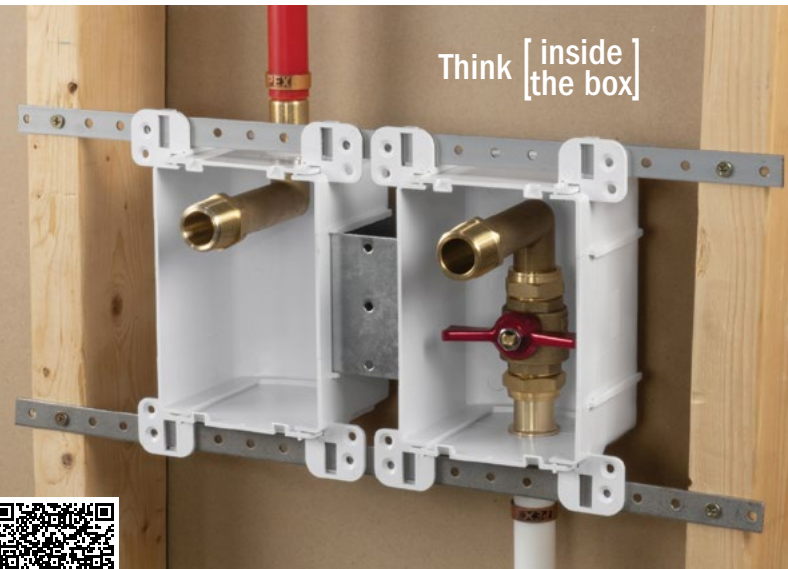

Saves Time | Simple, Consistent Installation | Code-Compliant

Supply

Drainage

Support

Specialties

www.siouxchief.com

TAKE THE FIELD.



SLUYTER

CONNECTED THROUGH CHEMISTRY



Solvent
Cements
Trusted by
Plumbers
and
Contractors
Since 1965



Simply difficult.





Simply smarter.



W-series Clamps

The new alternative to the strut and cushion clamp.

-  One piece design, installs with one hand
-  No assembly required to fix pipe
-  One clamp for both indoor and outdoor use

Simplicity. Reinvented.



TENZO 
FINE PLOMBERIE

TIMELESS ELEGANCE

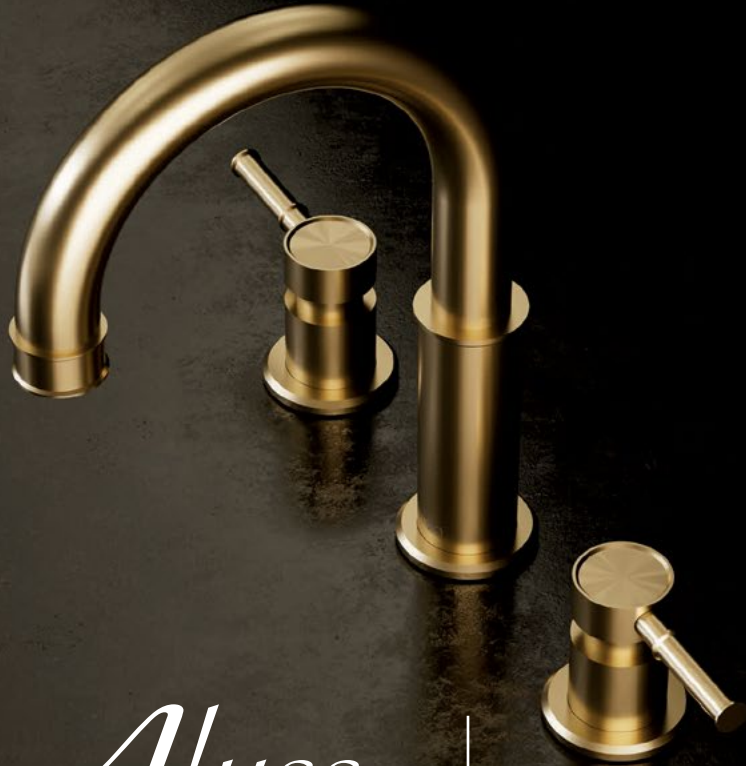

Alyss COLLECTION

Whether you're envisioning a classic bathroom or a contemporary shower, the Alyss collection is designed to meet your requirements and exceed your expectations thanks to its versatility. In fact, every product in this collection can be matched to a wide range of interior styles, from a modern look to a more rustic styling as you can see below.

LAVATORY FAUCET ALY13-BG

BG Connect

STAY CONNECTED LIKE NEVER BEFORE



Scan QR Code to Get
Your Digital Copy



Sign Up for the
BG Connect Email Newsletter Today!

connect.bartlegibson.com/signup

Learn more at BGConnect.ca or ask your sales person today!

2024/2025 LIGHTING RESOURCE GUIDE

Browse our selection of lighting solution products.



Scan QR Code to Get Your Digital Copy



Available at your nearest branch.



ELECTRICAL



HISTORICAL FACT

In 1983, Bartle & Gibson's Edmonton Head Office becomes the first location to stock and sell electrical products.



Quality Canadian Made CSA & ISO 9001 Certified Enclosures, Pedestals, and Splitters



www.acemfg.com



NEW

BROAN Performance in ONE

The Only ERV with Infield Selectable Airflow Configuration (Patent pending)

CODE CONFIDENT
ONCE BALANCED ALWAYS BALANCED

ENERGY EFFICIENT
84% SRE
87% ASRE

TrueCFM™ guarantees performance in any install



Installing Fresh Air Systems has never been so simple.



Ai Series
110 to 160 CFM

Ai2 Series
HIGHER CFM
up to 230 CFM

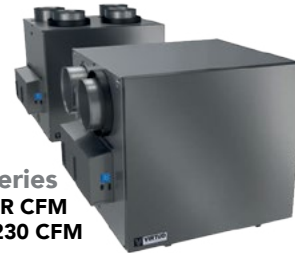

QUICKER SET-UP



CONSISTENT RESULTS



PREMIUM ECM MOTORS WITH BUILT-IN SMART TECHNOLOGY





EAST ELECTRICAL SUPPLY

- ✓ EMT
- ✓ RIGID
- ✓ ALUMINUM



Quality Products & Service



**CONDUIT ✓
ELBOWS ✓
NIPPLES ✓
COUPLINGS ✓
and More! ✓**

EastElectricalSupply.com

**GENLYTE
SOLUTIONS**
a signify business



With the unique convenience of adjustable color temperatures and/or lumen outputs, our new field selectable product line makes it easy to always have the right product for the job.

Learn more about additional QuickShip offerings at www.signify.com/quickship



LIGHTOLIER

ModuLyte Commercial Downlight

- CRI: 90 CRI
- CCT: 2700K, 3000K, 3500K, 4000K, 5000K
- Voltage: 120/277V 347V
- Size: 4", 6", 8"



LIGHTOLIER

Residential Retrofit Downlight Selectable

- CRI: 90 CRI
- CCT: 2700K, 3000K, 3500K, 4000K, 5000K
- Voltage: 120V
- Size: 4", 6"



Day-Brite CFI

HCY Sealed High Bay Selectable

- CRI: 80 CRI
- CCT: 4000, 5000K
- Voltage: UN3 (120-347V)

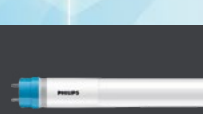

PHILIPS

FlexFit
(Hybrid UL Type A + B)

- CRI: 80 CRI
- CCT: 3000K, 3500K, 4000K, 5000K, 6500K
- Voltage: 120-277 V



KEENE

Lytepro Area

- CRI: 70 CRI
- CCT: 3000K, 4000K, 5000K
- Voltage: 120-277V 347-480V



KEENE

Slim Flood Dual Select

- CCT: 3000K, 4000K, 5000K
- Voltage: 120-347V
- Mounting: Knuckle Mount
Yoke Mount
Slipfitter Mount
Trunnion Mount



www.signify.com/quickship

Honeywell

POWER YOUR FUTURE PROFITABILITY!

Become a certified Honeywell Generators PRO today!

- The average Honeywell Generator installation proposal is **\$11,330**
- The home standby market has **grown 103% in the last 5 years**



POWERPERKS

A CONTRACTOR REWARDS PROGRAM

CONTRACTORS CAN NOW SIGN-UP FREE, EARN POINTS, AND REDEEM.

OVER 1000+ ITEMS TO CHOOSE FROM!



How to earn points

2 pts per dollar
on qualifying items

1 pt per dollar
on qualifying items



What you can earn

iPads, tickets, smart TVs, DeWalt tools and more!



How to redeem your rewards

Log into PowerPerks either online or through the app



Sign up today!

Scan here to get started

©Generac Power Systems, Inc. All rights reserved. Specifications subject to change without notice. The Honeywell trademark is used under license from Honeywell International Inc. Honeywell International Inc. makes no representation or warranties with respect to these products.

NEW!

CHANGING THE GAME

61-946
61-948

Get the latest technological advances, and features including TightSight® display and (patent-pending) continuity testing - all at an affordable price.

DISCOVER THE ALL-NEW IDEAL SURETRACE™ CIRCUIT TRACERS



LEARN MORE



31-656
31-657

NEW!

Digital Blued-Steel™ Fish Tape w/BlueView™ Display

Work smarter with accurate, real-time length measurements.

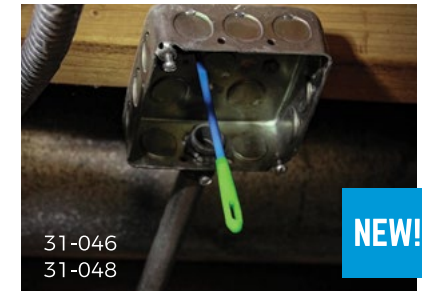

31-046
31-048

NEW!

E-Class™ Fibreglass Fish Tape w/Glow in Dark Eyelet

Smooth manoeuvrability; Non-conductive up to 1,000V

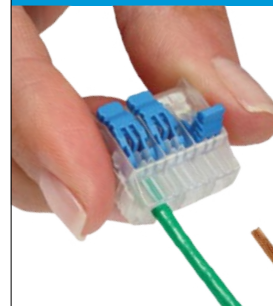

IDEAL Lever Connectors.
Simple fast connections. Available with 2, 3 or 5-ports.



When performance matters, count on **WireArmour™ General Purpose Electrical Tape**

Black 46-1700
Colours 46-1700C-XXX

LEARN MORE
idealind.com

THE ELECTRICIAN'S
CHAMPION™



PanelGuard™

Industrial-Grade Surge Protection



The Return of a Trusted Defender

PanelGuard™ makes it easy for specifiers to implement a robust surge protection solution that's tailored to meet project and application needs. The customizable SPD offers up to 7 modes of protection, multiple status alert types and two housing styles.

Choose PanelGuard on new construction and retrofit projects for reliable surge protection from a brand you can trust.

Learn more today at [Intermatic.com/panelguard](https://www.intermatic.com/panelguard)

L10 Series **H Series** **L5 Series**

Expanded Possibilities



Low-Profile Expandable In-Use Weatherproof Covers

Tired of fussing with bulky, hard-to-open weatherproof covers? Upgrade your next project with **Low-Profile Expandable In-Use Weatherproof Covers** from Intermatic.

Combining the durable construction installers count on with improved aesthetics and a sleek, modern design, low-profile in-use covers are a fresh alternative to traditional weatherproof cover options. Available in standard and extra-duty configurations, low-profile in-use covers include an expandable front window that can be collapsed to save space when not in use as well as a no-hassle latch, with lockable hasp, that can be opened effortlessly with one hand.

Learn more today at [Intermatic.com/low-profile-in-use-cover](https://www.intermatic.com/low-profile-in-use-cover)

WP7000G

LED Performance to Meet Your Needs



NightFox™ Photocontrols

Maximize your LED investment while saving on energy and maintenance costs with long-lasting photocontrols from Intermatic.

NightFox™ Photocontrols provide municipalities and utilities with a solution that's designed to meet their unique needs and budgets without sacrificing performance.

Tested to match the demands of LED fixtures and backed by a minimum eight-year warranty, they're an excellent choice for projects of all sizes.

Learn more today at [Intermatic.com/photocontrols](https://www.intermatic.com/photocontrols)

[Intermatic.com](https://www.intermatic.com)

INTERMATIC®

Now Available In 347 V

EK4336S **120-277V** EK4436SM **LED4536SC**

WORRY-FREE ALARMS

10-YEAR BATTERY BACKUP NEVER NEEDS CHANGING



21027904

21027905



21027904 – 120V Smoke Alarm, 10-year Battery Backup

21027905 – 120V Talking Smoke & CO Alarm, 10-year Battery Backup

- Say goodbye to low-battery chirps and save money – with no batteries to buy or replace, save on battery and labour costs for the life of your alarms – lasts 10 years.

PRO SERIES ALARMS



P1275CA

21032311



P1275CA – 120V Smoke Alarm, 9V Battery Backup

21032311 – 120V Talking Smoke & CO Alarm

- All Pro Series smoke and combination alarms have a Hush™ feature to silence nuisance alarms and are listed by UL to CAN/ULC-S531
- All Pro Series carbon monoxide and combination alarms are listed by CSA and meet CSA 6.19 standards.
- Alarms last 10 years from activation – up to 40% longer than other alarms.

www.kiddecanada.com

KIDDE™ THE CHOICE OF PROFESSIONALS



The Leviton Load Center

The Future Made Current

- Safer
- Faster Installation
- Approachable
- Smart*



*Optional Smart Functionality (must install Smart components to use with the My Leviton app)



How to Make a Leviton Load Center Smart

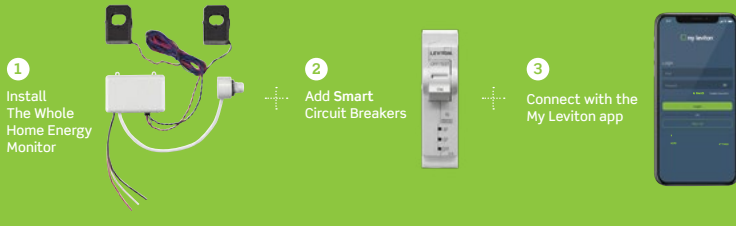

THE FUTURE IS ON®
www.leviton.com



STEP UP TO HIGHER QUALITY LIGHTING AND REDUCE GLARE

SLIMLED

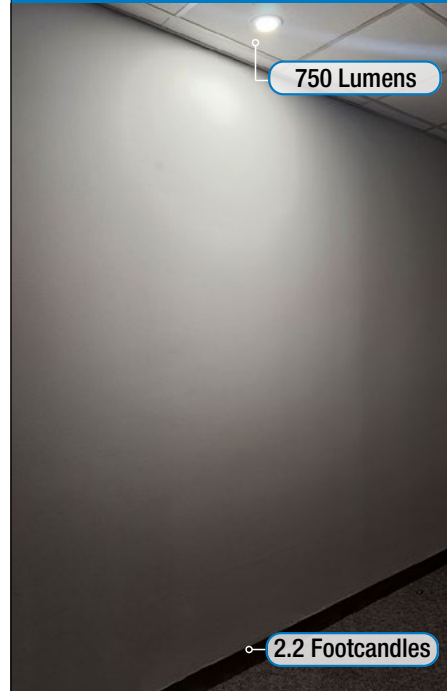

750 Lumens

2.2 Footcandles

ANGULAR DISTRIBUTION

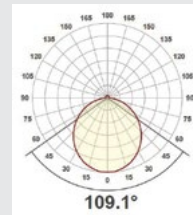

OPTICS

- Flood Lighting
- Glare



LUNA

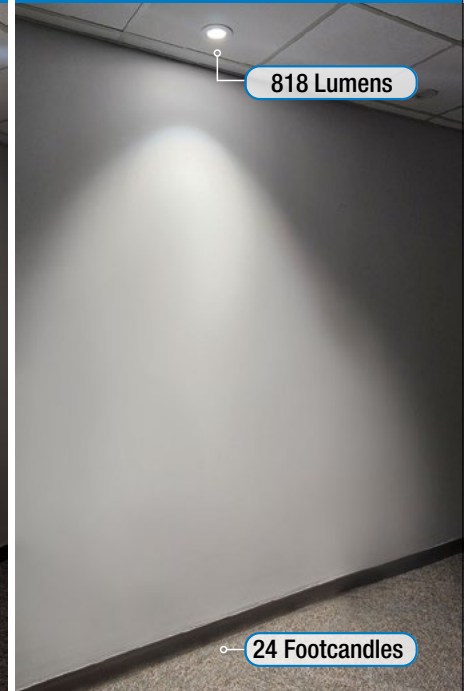

818 Lumens

24 Footcandles

ANGULAR DISTRIBUTION

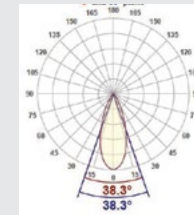

SAME EASE OF INSTALLATION & DRIVER, WITH IMPROVED OPTICS!

OPTICS

- Comfort
- High performance



LITELINE.COM



Lithonia® FRAME

The Lithonia® FRAME by Lithonia Lighting® offers a modern, upscale aesthetic with functionality and performance to match.



we can fit 72 2x4 fixtures and 120 2x2 fixtures on a pallet



www.acuitybrands.ca

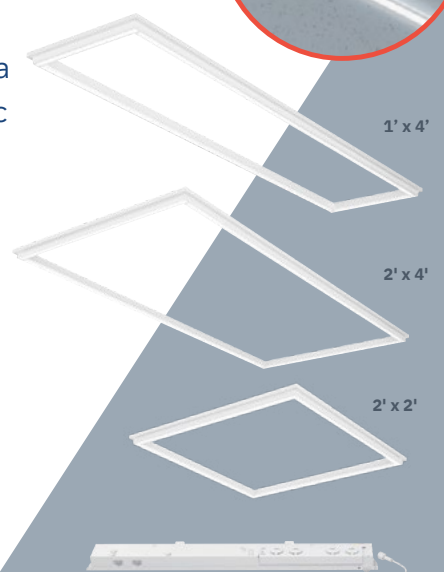

MERSEN
ELECTRICAL
COMPONENTS
PROTECT
YOUR
BUILDINGS
FROM
THE
GROUND
UP

EP-CA.MERSEN.COM

Mersen's overcurrent and overvoltage protection products are designed to meet the demands of new construction projects and safety code requirements, modernize aging infrastructure, and protect equipment, data, and most importantly, people.

Primary & Secondary Service Entrance



HVAC



Data/Lighting Control



Emergency Circuits



National

Cable Specialists

One-stop shop for all your electric and electronic wire, cable and accessory needs!

FIBER OPTIC

- Armoured Fiber
- Connectors
- Multi-Mode Fiber
- Patch Panels
- Patch Cords
- Single Mode Fiber
- Splice Enclosures
- Termination Boxes

BUILDING WIRE

- AC90
- ACWU90
- Bare Copper
- Tinned Copper
- Copper Conductor
- Aluminum Conductor
- Corflex
- NMD90/NMWU90
- RW90/RWU90
- T90

INDUSTRIAL WIRE & CABLE

- DLO
- MICA Wire
- Motor & Lead Wire
- Portable Cord
- Retractable Cord
- Stage Lighting Cable
- TCGT
- Tefzel, Sew-2, Teflon
- UL & CSA Style Lead Wire
- Welding Cable

UTILITY CABLE

- ACSR
- Airport Lighting Cable
- High Voltage Cable
- Overhead Service (NS-75)
- XLP Power Cable
- Underground Service (USEI90/USEB90)

TECK CABLE

- Aluminum Armour
- Aluminum Conductor
- Copper Conductor
- Medium & High Voltage
- Riser Teck
- Steel Armour

BUILDING CONTROL SYSTEMS & COMMUNICATION

- Category Cables (Armoured or Unarmoured)
- Coaxial/Twinaxial Cables
- Fire Alarm Cable
- Multi-Conductor Cable
- Multi-Pair Cable FT4/FT6
- OSP Telco
- Patching Systems
- Speaker Wire
- Thermostat Wire

Accessories



NSPEC
BRANDED PRODUCTS



Value Added Services



Paralleling



Product Tracking



Cut-to-Length



Custom Shipping



Material Storage



Master Reels



Pulling Eye Installation



Custom Tagging



Stripping, Dying, Twisting

STANPRO

EMERGENCY

Stanpro's emergency lighting line consists of signs, combos, remotes and battery units. Stanpro uses the latest technologies to maximize the performance, reliability and cost efficiency of its products designed and manufactured in Canada while meeting the highest standards in the industry.

EXPLORE OUR READILY AVAILABLE EMERGENCY LIGHTING PRODUCTS THAT WILL BEST SUIT YOUR PROJECTS.

REMOTES

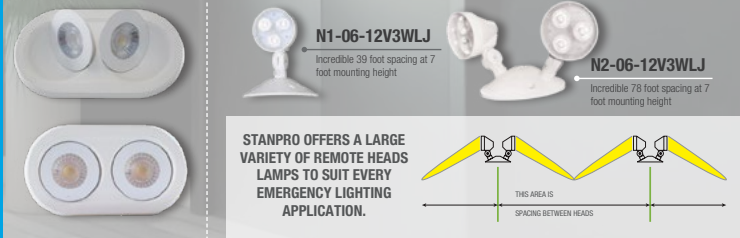

COMBOS



SIGNS



BATTERY



standardpro.com



SCAN HERE FOR MORE INFORMATION



SCAN HERE FOR MORE INFORMATION

THE SMART CHOICE: ECO-DESIGNED AND EASY-TO-USE.

Nexans AC90 Low Carbon



- New design with -10% CO₂ savings
- Easy to Use
- Environmental Product Declaration
- Length Indicator Label



SCAN TO LEARN MORE



Nexans
ELECTRIFY THE FUTURE

TECHSPAN



TECHSPAN.CA

Wire Management and Termination Products



Protecting Essential Electrical Infrastructure

Rigid PVC Conduit Pipe and Fittings for Exposed, Encased and Underground Applications

Westlake Pipe & Fittings manufactures a complete line of Rigid PVC Conduit pipe and fittings for electrical applications. Our products are designed to help reduce labor and maintenance costs, while offering sound, reliable performance. Westlake Pipe & Fittings' Rigid PVC

Conduit can be used for direct burial, requiring no additional protection for installations according to the Canadian Electrical Code (CEC).



Performance You Can Count On

Our products are certified by the Canadian Standards Association (CSA) and Underwriters Laboratories (UL) for use in above and below ground applications and conduit meets NEMA TC-2. Schedule 40 Rigid PVC conduit pipe is available in 1/2- to 6-inch-diameter and 10- or 20-foot-lengths. Westlake Pipe & Fittings products are impact resistant – made from tough, durable, high tensile strength PVC that resists cracking and is long lasting.

westlakepipe.com/electrical

©2024 Westlake Pipe & Fittings All rights reserved.

Westlake
Pipe & Fittings

A Better Foundation™



BARTLE & GIBSON
SHOWROOMS
kitchen & bath fixtures

inspiration lives here

showroom LOCATIONS

VISIT ONE OF OUR BEAUTIFUL SHOWROOMS TODAY!

BRITISH COLUMBIA

COURTENAY MOVING FALL 2024 TO
4625 MADRONA PLACE
#3-2989 Kilpatrick Ave.
P: 250.334.0645
bgscourtenay@bartlegibson.com

NANAIMO

2067 Boxwood Road
P: 250.758.1771
bgsnanaimo@bartlegibson.com

PORT COQUITLAM

1391 Kebet Way
P: 250.941.7318
bgsportcoquitlam@bartlegibson.com

PRINCE GEORGE

3500 Massey Drive
P: 250.562.5505
bgsprincegeorge@bartlegibson.com

VICTORIA

4248 Glanford Ave.
P: 250.727.9976
bgsaanich@bartlegibson.com

WEST KELOWNA

1115 Stevens Road
P: 250.769.3101
bgswestkelowna@bartlegibson.com

ALBERTA

CALGARY
4300 - 21 Street NE
P: 403.291.1099
bgsocalgary@bartlegibson.com

EDMONTON

13475 Fort Road
P: 780.472.2850
1.800.661.5615
bgsedmonton@bartlegibson.com

MEDICINE HAT

2021 - 10 Ave SW
P: 403.527.3565
bgsmedicinehat@bartlegibson.com

RED DEER

7550 Johnstone Drive
P: 403.340.1650
bgsredeer@bartlegibson.com

follow along

   @BGSHOWROOMS

VISIT US IN PERSON
OR ONLINE AT BGSHOWROOMS.COM

ALBERTA

sales.ab@bartlegibson.com

Airdrie

102 – 2956 Kingsview Blvd
Ph (403) 945-9481
Fax (403) 945-9487

Barrhead

6128 – 46 Street
Ph (780) 674-4255
Fax (780) 674-2833

Calgary – Northeast

4300 – 21 Street NE
Ph (403) 291-1099
Fax (403) 291-2849
1-877-303-3933

Calgary – South Side

3405 – 9th Street SE
Ph (403) 216-6717
Fax (403) 252-6881

Edmonton – North Side

13475 Fort Road
Ph (780) 472-2850
Fax (780) 476-6686
1-800-661-5615

Edmonton – South Side

6742 – 59 Street
Ph (780) 437-7767
Fax (780) 437-6319

Edson

4508 B 2nd Avenue
Ph (780) 723-6180
Fax (780) 723-7493

Fort McMurray

8220 Manning Ave
Ph (780) 743-4476
Fax (780) 791-6616

SASKATCHEWAN

sales.sk@bartlegibson.com

Swift Current

633 North Railway Street West
Ph (306) 773-1800
Fax (306) 773-1817

BRITISH COLUMBIA

sales.bc@bartlegibson.com

Chilliwack

44653 Yale Road West
Ph (604) 792-0866
Fax (604) 792-7622

Courtenay

*MOVING FALL 2024 TO
4625 MADRONA PLACE*
Unit 3, 2989 Kilpatrick Ave
Ph (250) 334-0645
Fax (250) 334-3929

Langford

2665 Sooke Road
Ph (250) 389-1073
Fax (250) 478-3297

Maple Ridge

23652 Dewdney Trunk Rd
Ph (604) 467-1535
Fax (604) 467-3424

Nanaimo

2067 Boxwood Road
Ph (250) 758-1771
Fax (250) 758-4640

North Vancouver

1159 – 16 Street
Ph (604) 988-4141
Fax (604) 988-6633

NORTHWEST TERRITORIES

salesywk@bartlegibson.com

Yellowknife

324 Old Airport Road
Ph (867) 920-2248
Fax (867) 873-5730

Port Coquitlam

1391 Kebet Way
Ph (604) 941-7318
Fax (604) 941-7218

Prince George

3500 Massey Drive
Ph (250) 562-5505
Fax (250) 562-5073
1-866-580-5505

Saanich

4248 Glanford Avenue
Ph (250) 727-9976
Fax (250) 727-0547

Surrey

7815 King George Blvd
Ph (604) 502-9122
Fax (604) 502-9133

West Kelowna

1115 Stevens Road
Ph (250) 769-3101
Fax (250) 769-0559

Whistler

101 – 1410 Alpha Lake Rd
Ph (604) 932-4871
Fax (604) 932-2437



View the interactive digital catalogue at
connect.bartlegibson.com/2024-25catalogue